

HLS102 - Hazchem Sign

Hazardous chemical (hazchem/Emergency Information Panel) sign with hinged leaves.

This lightweight sign brings together both the strength of steel with the lightness and durability of aluminium to produce a versatile hinged hazchem sign to comply with Australian Dangerous Goods code version 7.

Features and Benefits

- EIP meets the government requirements for the transport of dangerous goods.
- Spring clips on each side secure leaves in place, with rubber buffers in between to stop vibration.
- Customer contact details can easily be added to the sign as required.
- Hinged panel sub-assemblies are replaceable.
- Inserts are available that can be easily slotted into place.
- Can display up to 4 dangerous goods in its standard state (Petrol, Petroleum Fuel, Combustible Liquid & a blank panel to indicate an empty tank or for customisation).
- With the addition of the HLS102-8 special sign insert, an additional 2 dangerous goods can be displayed*.



HLS102 Model Shown

Technical Information

Materials	Frame - Aluminium. Main sign - Aluminium powder coated. Hinged Signs - Galvanised Steel powder coated. Hinges - Steel Zinc plated. Buffers - Rubber. Pop rivets - Aluminium.
Standards	Complies with Australian Dangerous Goods Code, 7th Edition
Dismantle	If replacement of the leaves is required simply drill out 8 off pop rivets and replace the leaves using a hand operated pop rivet gun.
Mounting	4 off M8 Bolts.
Weight	5.3 kg each (Total for Tank = 16 kg).

Ordering Information

HLS102: Hazchem Sign - Standard state.

HLS102-BIT: Alternate Part – For BITUMEN PRODUCTS.

Associated Equipment

HLS102-8: Special Insert with text as required.

HLS102-9: Special Insert – AVIATION TURBINE FUEL & AVIATION GASOLINE.

HLS102-12: Special Insert - ETHANOL & METHANOL.

HLS102-20: Bitumen Hazchem sign replacement sub assembly.

HLS102-30: Standard Hazchem sign replacement sub assembly.

* - Pending Configuration.

HLS102 - Hazchem Sign

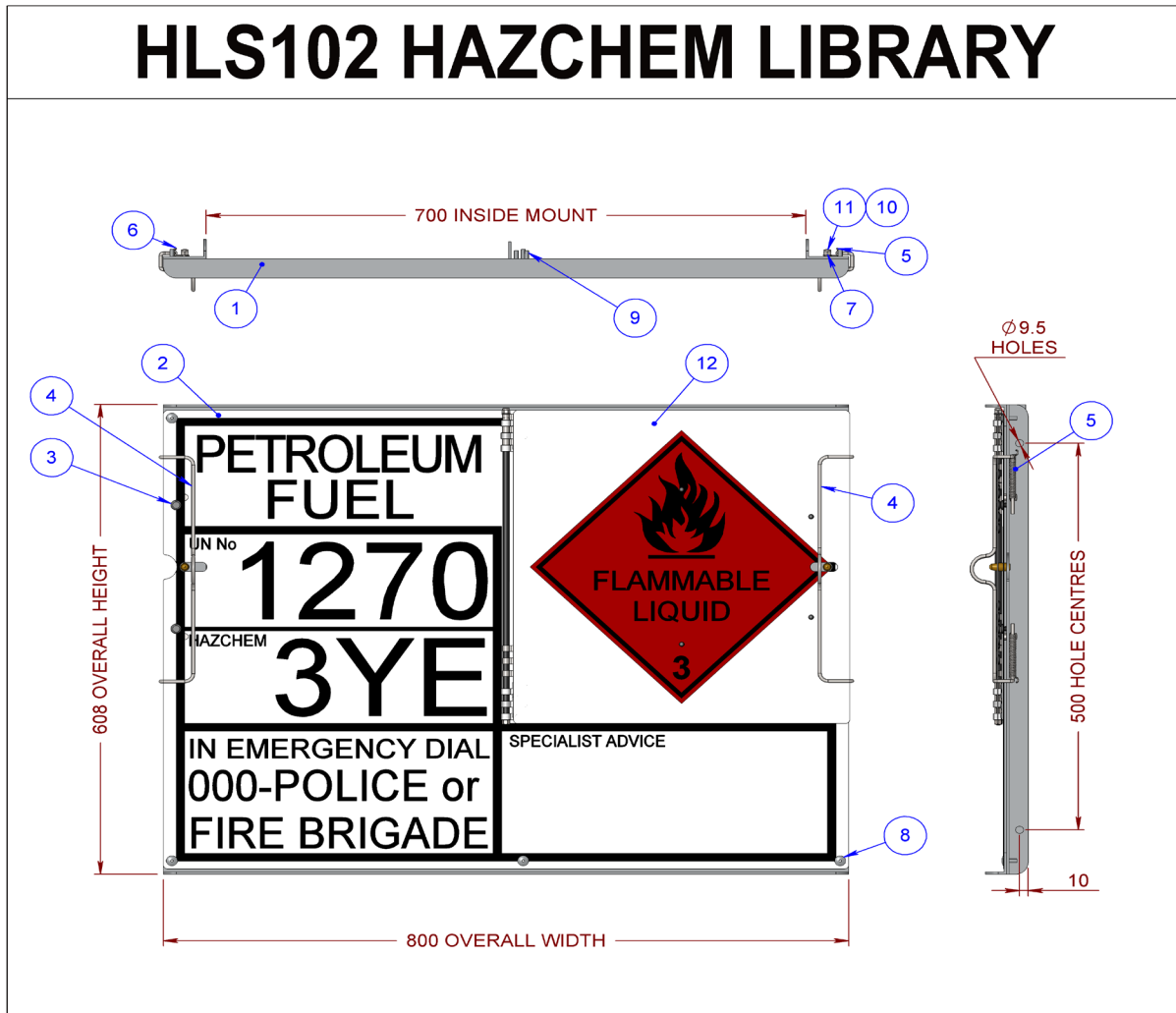

ITEM NO.	PART NUMBER	DESCRIPTION	HLS102	HLS102-BIT	MATERIAL
1	HLS101-1	FRAME SIGN HAZCHEM ASSEMBLY	1	1	ALUMINIUM
2	HLS101-12	SIGN HAZCHEM 800 x 600 BITUMEN	-	1	ALUMINIUM
	HLS101-6	SIGN HAZCHEM 800 x 600	1	-	ALUMINIUM
3	7125	GROMMET BUFFER SIGN HAZCHEM	4	4	NEOPRENE
4	7146	LATCH WIRE HAZCHEM SIGN	2	2	STEEL
5	4431	SPRING SIGN HAZCHEM	2	2	STEEL
6	4430	SPRING SIGN HAZCHEM	2	2	STEEL
7	6541	WASHER FLAT	4	4	Z/P STEEL
8	5629	POP RIVET	5	5	ALUMINIUM
9	0008	POP RIVET	8	8	ALUMINIUM
10	0156	NUT NYLOC	4	4	Z/P STEEL
11	4983	SETSCREW METRIC	4	4	Z/P STEEL
12	HLS102-30	SIGN LEAVES SUB-ASSEMBLY	1	-	STEEL
	HLS102-20	BITUMEN HAZCHEM SIGNS	-	1	STEEL LEAVES,

METERS - VALVES - VENTS - MANHOLES - HOSEREELS - OVERFILL PROTECTION - LOADING ARMS - ELECTRONIC DIPSTICKS



LIQUIP
 P.O. Box 7049
 Wetherill Park BC, 2164
 Sydney NSW Australia
 Email: liquip@liquip.com
 Phone: +612 9725 9000
 Fax: +612 9725 1252

DISTRIBUTORS
 See website for Liquip branches and Distributors
www.liquip.com

X550205

Sheet 1 of 3
 Issue: E

HLS102 - Hazchem Sign

HLS102 HAZCHEM LIBRARY

FOUR OFF DISPLAYS POSSIBLE WITH HLS102

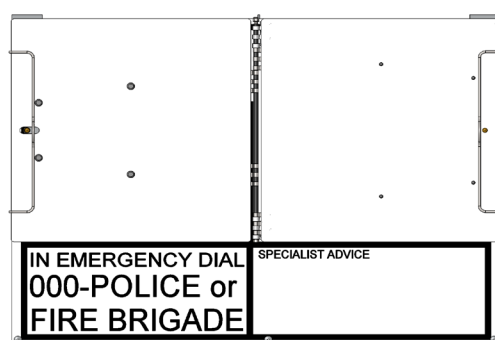
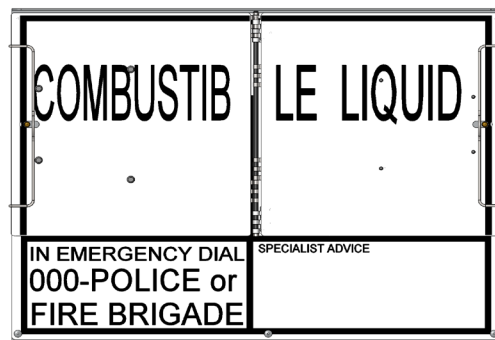
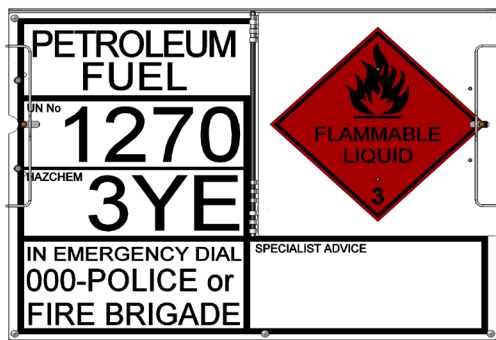

METERS - VALVES - VENTS - MANHOLES - HOSEREELS - OVERFILL PROTECTION - LOADING ARMS - ELECTRONIC DIPSTICKS



LIQUIP
 P.O. Box 7049
 Wetherill Park BC, 2164
 Sydney NSW Australia
 Email: liquip@liquip.com
 Phone: +612 9725 9000
 Fax: +612 9725 1252

DISTRIBUTORS
 See website for Liquip branches and Distributors
www.liquip.com

X550205

Sheet 2 of 3
 Issue: E

HLS102 - Hazchem Sign

HLS102 HAZCHEM LIBRARY

SIGN LEAVES SUB-ASSEMBLY (HLS102-30)

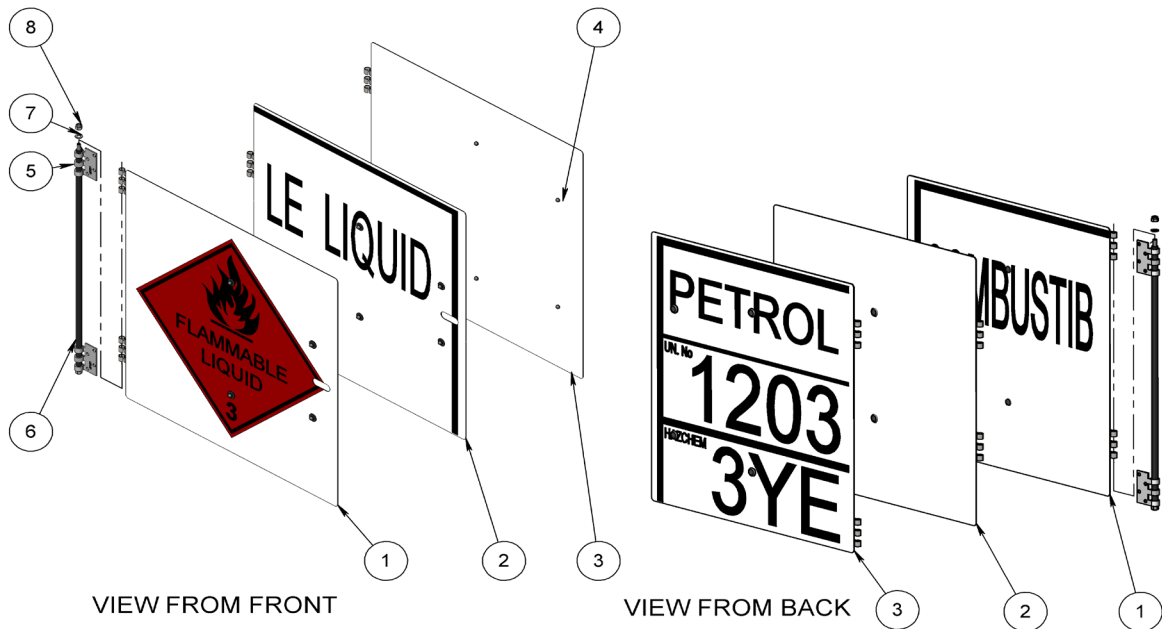

ITEM	PART NUMBER	DESCRIPTION	QTY.	MATERIAL
1	HLS102-2	SIGN HAZCHEM 400 X 400	1	STEEL
2	HLS102-11	SIGN HAZCHEM 400 X400	1	STEEL
3	HLS101-4	SIGN HAZCHEM 400 X 400	1	STEEL
4	7125	GROMMET BUFFER SIGN HAZCHEM	12	NEOPRENE
5	7259	HINGE STRAIGHT SIGN HAZCHEM	2	STEEL
6	HLS101-5A	HINGE PIN WITH BEARING	1	ST STEEL
7	6541	WASHER FLAT	1	Z/P STEEL
8	0156	NUT NYLOC	1	Z/P STEEL

METERS - VALVES - VENTS - MANHOLES - HOSEREELS - OVERFILL PROTECTION - LOADING ARMS - ELECTRONIC DIPSTICKS



LIQUIP
 P.O. Box 7049
 Wetherill Park BC, 2164
 Sydney NSW Australia
 Email: liquip@liquip.com
 Phone: +612 9725 9000
 Fax: +612 9725 1252

DISTRIBUTORS
 See website for Liquip branches and Distributors
www.liquip.com

X550205

Sheet 3 of 3
 Issue: E

HLS102 - Hazchem Sign

HLS102-BIT BITUMEN HAZCHEM LIBRARY

FOUR OFF DISPLAYS POSSIBLE WITH HLS102-BIT

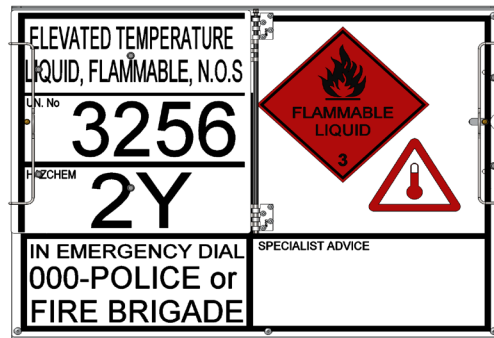
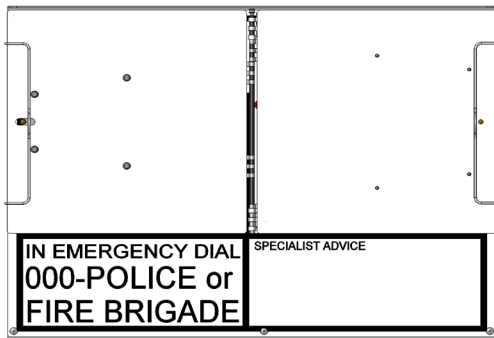
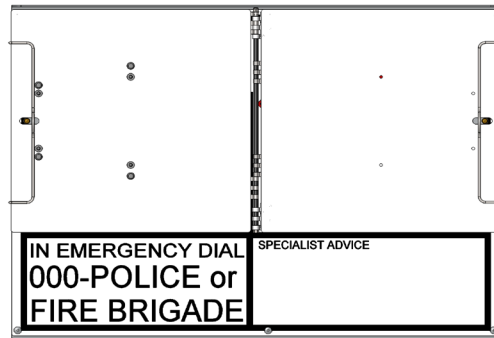
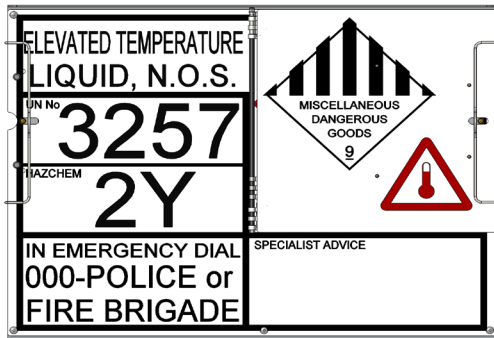

METERS - VALVES - VENTS - MANHOLES - HOSEREELS - OVERFILL PROTECTION - LOADING ARMS - ELECTRONIC DIPSTICKS



LIQUIP
 P.O. Box 7049
 Wetherill Park BC, 2164
 Sydney NSW Australia
 Email: liquip@liquip.com
 Phone: +612 9725 9000
 Fax: +612 9725 1252

DISTRIBUTORS
 See website for Liquip branches and Distributors
www.liquip.com

X550009

Sheet 1 of 2
 Issue: C

HLS102 - Hazchem Sign

HLS102-BIT BITUMEN HAZCHEM LIBRARY

BITUMEN SIGN LEAVES ASSEMBLY (HLS102-20)

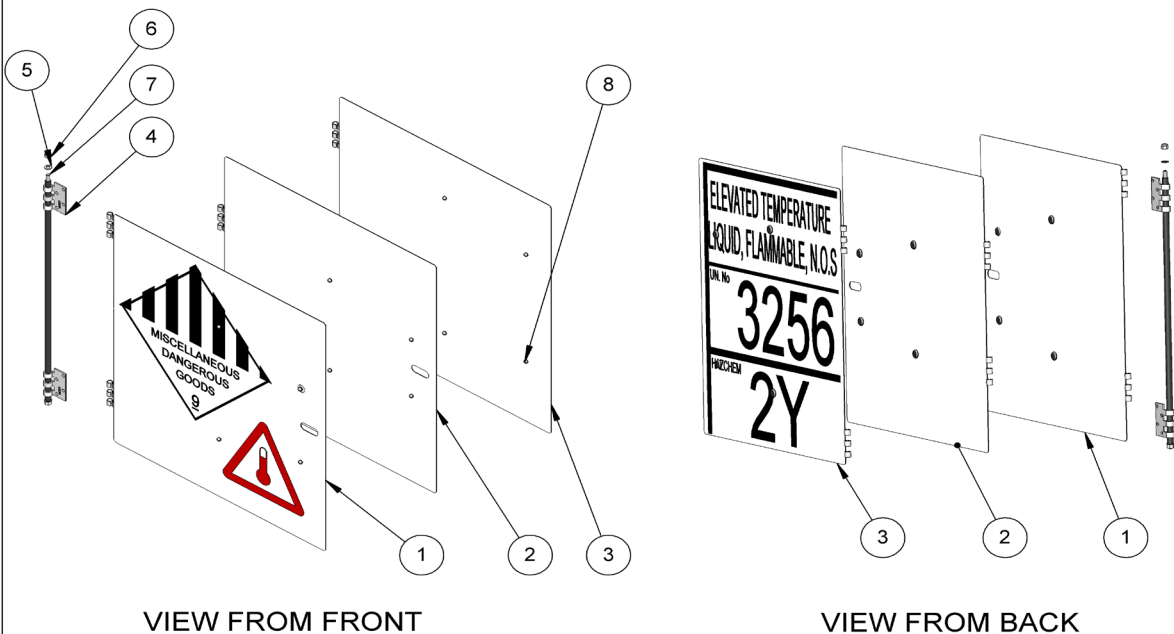

ITEM	PART NUMBER	DESCRIPTION	QTY.	MATERIAL
1	HLS102-2-BIT	SIGN HAZCHEM 400 x 400	1	STEEL
2	HLS102-11	SIGN HAZCHEM 400 x 400	1	ALUMINIUM
3	HLS101-4-BIT	SIGN HAZCHEM 400 x 400	1	ALUMINIUM
4	7259	HINGE STRAIGHT SIGN HAZCHEM	2	STEEL
5	6541	WASHER FLAT	1	Z/P STEEL
6	0156	NUT NYLOC	1	Z/P STEEL
7	HLS101-5A	HINGE PIN WITH BEARING	1	ST STEEL
8	7125	GROMMET BUFFER SIGN HAZCHEM	12	NEOPRENE

METERS - VALVES - VENTS - MANHOLES - HOSEREELS - OVERFILL PROTECTION - LOADING ARMS - ELECTRONIC DIPSTICKS



LIQUIP
 P.O. Box 7049
 Wetherill Park BC, 2164
 Sydney NSW Australia
 Email: liquip@liquip.com
 Phone: +612 9725 9000
 Fax: +612 9725 1252

DISTRIBUTORS
 See website for Liquip branches and Distributors
www.liquip.com

X550009

Sheet 2 of 2
 Issue: C